

Z506

User Manual

Realtimes Beijing Technology Co., LTD.

Fax: +86 010-84284669 / 84280996

Email: info@realtimes.cn

Web Page: <http://www.realtimesai.com>

Address: 11th Floor, Block B, 20th Heping Xiyuan, Pingxi Street, Chaoyang District, Beijing 100013, P.R.China



Revision History

Revision	Date	Reason for change	Applicable hardware version	Modified by
V1.0	2020-02	Initial release	V1.0	
V2.0	2021-05	Add line package configuration	V2.0	144



Electronic components and circuits are very sensitive to electrostatic discharge. Although our company designs anti-static protection for the main interfaces on the card when designing circuit board products, it is difficult to achieve anti-static safety protection for all components and circuits. Therefore, it is recommended to observe anti-static safety precautions when handling any circuit board component (including Z506). Anti-static safety protection measures include, but are not limited to the following:

- a) The smart box should be placed in an anti-static bag during transportation and storage, and then the board should not be taken out during installation and deployment.
- b) Before touching the smart box, discharge the static electricity stored in the body: wear a discharge grounding wrist strap.
- c) Operate the smart box only within the safe area of the electrostatic discharge point.
- d) Avoid moving smart boxes in carpeted areas.

Precautions and after-sales maintenance

matters needing attention

Before using the product, please read this manual carefully and keep it for future reference;

- Please pay attention to and follow all warning and guidance information marked on the product;
- Please use matching power adapter to ensure the stability of voltage and current;
- Please use this product in a cool, dry and clean place;
- Do not use this product in cold and hot alternate environment to avoid condensation damage components;
- Do not splash any liquid on the product. Do not use organic solvent or corrosive liquid to clean the product;
- Do not use the product in dusty and messy environment. If it is not used for a long time, please pack the product;
- Do not use in the environment with excessive vibration, any dropping or knocking may damage the circuit and components;
- Do not plug and unplug the core board and peripheral modules when power is on;
- Please do not repair or disassemble the product by yourself. In case of any fault, please contact



our company in time for maintenance;

- Do not modify or use unauthorized accessories by yourself, and the damage caused will not be warranted;

After sales maintenance

1) Warranty period

- Base plate, core plate : 3 year (non-human damage)
- Other peripherals sold by the company: 1 year (non-human damage)

2) Warranty description

- Within 7 days: the product (base plate, core module) is not damaged by human, our company will replace / repair it free of charge, and bear the return freight; (because the core module needs NVIDIA to confirm that it can meet the requirements of repair, it will take a long time, we will coordinate as soon as possible, please forgive for the inconvenience)

- From 7 days to 36 months: the product (base plate, core module) is not damaged by human, our company will repair it free of charge, and bear the return freight; (because the core module needs NVIDIA to confirm that it can meet the requirements of repair, it will take a long time, we will coordinate as soon as possible, please forgive for the inconvenience)

- Artificial damage in more than 3 year or 3 year: the product (carrier plate) shall be tested after it is sent to the customer, and the customer shall be informed of whether it can be repaired and the maintenance cost in detail. After reaching an agreement, the product shall be repaired and returned to the customer, and the company shall bear the return freight;

- The starting time shall be subject to the date of express delivery receipt;

3) Contact information

Official website: www.realtimesai.com

Taobao website: <https://shop340963258.taobao.com/>

Address: 11, block B, Heping Xiyuan, Heping West Street, Chaoyang District, Beijing

Attention: RMA

Tel: 010-84284669

Mailing notice: contact with the company's sales department in advance, arrange technical support personnel to check and eliminate errors caused by misoperation as soon as possible, fill in the product after-sale return to factory maintenance form after verification, and send it to rma@realtimes.cn Mail box, please attach the list of items to facilitate verification, so as to avoid loss and loss in the process of express delivery. The company does not receive any delivery

Technical support and development customization

1. Scope of technical support

- 1) The company releases the electrical characteristics and use of industrial carrier boards and modules;
- 2) Physical dimension of hardware, relevant structure diagram and line sequence definition of specific interface;
- 3) Burn in verification of all BSP support packages provided by the company;
- 4) The company released burn environment construction, entry-level use. ;
- 5) Various peripheral module drivers released by the company;
- 6) The company's product fault diagnosis and after-sales maintenance services;

2. Scope of technical discussion



Due to the wide range of embedded system knowledge and various types of involvement, we can not guarantee that all kinds of questions can be answered one by one. The following content is not available for technical support, only suggestions can be provided.

- 1) Knowledge beyond the course published by our company;
- 2) Specific software program design;
- 3) Technical support for industrial carrier not issued by the company;
- 4) All kinds of driving support for industrial carrier board not issued by the company;
- 5) Hardware principle and drive design of peripheral module not issued by our company;

3. Technical support mode

- 1) Official website or email questions (recommended): <https://www.realtimesai.com/cn/download.html>
techsupport@realtimes.cn
- 2) Official Taobao through Alibaba Wangwang consultation: <https://shop340963258.taobao.com/>
- 3) Wechat group consultation (wechat Group No. consults Taobao customer service or sales, and Taobao purchase order No. needs to be provided for verification);
- 4) Technical support email: techsupport@realtimes.cn
- 5) Tel: 010-84284669

4. Technical support time

Monday to Friday; 8:30-12:00 am; 1:00-17:30 PM;

The company arranges the rest according to the national legal holidays, during which it may not be able to provide technical support, please send the problem to the technical support email. We will reply to you as soon as possible on weekdays.

5. Complaints and suggestions

If you are not satisfied with us or have suggestions, you can send an email to yu.qin@realtimes.cn
For feedback, please call 010-84284669 for further improvement.

6. Customized development services

The company provides the embedded operating system driver based on NVIDIA Jetson series and the paid customized development service of hardware carrier board to shorten your product development cycle.

Please email the request to info@realtimes.cn

Data acquisition and subsequent update

1. Access to information

Download on our website

The company's website contains supporting information of its products, including product user manual, NVIDIA Jetson series module data manual, BSP driver support package for carrier board, supporting peripheral driver files, interface test verification method, FAQ, system burning guide, etc.

get into www.realtimesai.com, select "data download" in the navigation bar, find the data you need, and click download.

2. Subsequent updates

Updates of subsequent documents, BSP, driver files and other official account will be updated in time. We will pay close attention to our developments in order to ensure that your information is up to date. We will push through WeChat public.



Table of Contents

1 PRODUCT INTRODUCTION.....6

 1.1 FEATURE.....6

 1.2 ORDERING INFORMATION.....7

 1.3 CABLE KITS AND ACCESSORIES.....7

2 EXTERNAL INTERFACE FUNCTION AND LOCATION.....8

3 INSTALLATION AND USE.....9

 3.1 HOW TO USE SMART BOX.....9

 3.2 RECOVERY MODE.....9

4 CONNECTORS DESCRIPTION.....10

 4.1 MINI HDMI INTERFACE.....10

 4.2 ETHERNET CONNECTOR.....10

 4.3 USB3.0 INTERFACE.....10

 4.4 SD CARD SLOT.....10

 4.5 POWER INPUT PORT.....11

 4.6 OTG-USB2.0 INTERFACE.....11

 4.7 FUNCTION CONNECTOR.....11

 4.8 WIFI ANTENNA CONNECTOR.....12

5 HARDWARE UPDATE HISTORY.....12

6 PRODUCT SIZE DIAGRAM.....12

7 SOFTWARE/BSP DETAILS.....13

TERMS OF WARRANTY.....14

1 Product introduction

Z506 is one based on NVIDIA Jetson™ NANO series™ module design of your new feiyun box, built-in integration 128 nuclear Maxwell™ architecture of GPU NANO module, Ubuntu 18.04 operating system, with 0.5 TFLOPS the AI processing capacity of floating point arithmetic, using super strong light aluminum alloy material design, transmitting heat, good heat dissipation ability, the overall size is small and light, good structure of human body engineering, obligate has easy the wing structure of installation, It has the stable operation capability of 7x24 ultra-long MTBF on site, which can be applied to autonomous machines such as robots, unmanned delivery vehicles, intelligent gate machines and intelligent sales containers, etc. It is an ideal carrier for deploying AI computing power for deep learning at the edge.

1.1 Feature

- Compatible with nvidia Jetson NANO module
 - ◆ GPU: NVIDIA Jetson™ NANO 128 core with NVIDIA Maxwell™ architecture (472 abbr.giga floating-point operations per second),
 - ◆ CPU: ARM Cortex-A57 (quad-core)
 - ◆ Operating system: Linux pre-installed
 - ◆ Memory: 4GB LPDDR4
 - ◆ Storage: Built-in 16GB or expandable TF card slot
- 1 x Mini HDMI 2.0 interface
- 1 x USB3.0 interface , 1 x USB2.0, 1 x USB2.0 OTG
- 2 x UART
- 1 x mini PCIE interface
- 1 x GbE (10/100/1000 BASE-T)
- 1 x Micro SD Card slot
- 1 x Micro SIM Card slot
- 1 x Button interface
- Size: 96mm×92mm×37.87mm
- Power input: +12V DC 输入
- Temperature: -25℃—+65℃
- Weight: 406g

1.2 Ordering Information

Model Options	Functional Description
Z506	NANO Feiyun Smart Box Conductive Cooling Edition, built-in NANO B01 module, pre-installed Ubuntu 18.04, built-in 16GB eMMC; 1 x USB 3.0, 1 x USB 2.0, 1 x USB OTG, 1 x miniHDMI, 1 x GbE, 1x Micro SD, 3x 3.3V UART, 2 x SPI, 2 x I2C, 1 x MiniPCIe, WIFI and Bluetooth optional; power indicator light, power switch button, -20——+65℃; including cable package (HDMI, serial port, SPI, I2C); includes power adapter, provides Ruitai new era RTS Linux4Tegra software support package, and has passed 3C and CE certification
RTS-NANO-AC/DC	Power Adaptor for Z506-12V
RTSV-6911i(optional) RTSV-6901(optional) RTSV-6941(optional)	Mini-pcie Video Capture Card,RTSV-6911i (8-channel D1 NTSC/PAL video input), RTSV-6901 (single-channel SDI video input), RTSV-6941 (single-channel HDMI Video Input)

Order online:

<https://shop340963258.taobao.com>

<https://mall.jd.com/index-824786.html>

1.3 Cable Kits and Accessories

Component	Number	Functional Description
microHDMI to HDMI cable	1	Convert Micro HDMI to standard HDMI interface

2 External interface function and location



Z506 FRONT



Z506 BACK

3 Installation and use

3.1 How to use Smart Box

- a) Ensure that the voltage of all external systems is turned off
- b) Install necessary external cables. (Such as: the display cable connected to the HDMI display, the power input cable to power the system, the USB cable connecting the keyboard and mouse ...)
- c) Connect the power cord to a power source.
- d) Connect to the power supply of Z506, the system will start working after power on.

3.2 Recovery mode

Jetson NANO core module can work in normal mode and Recovery mode, under which file system update, kernel update, Boot Loader update, BCT update and other operations can be carried out.

The steps to enter the Recovery mode are as follows:

- a) Turn off the power supply to the system.
- b) Use a USB cable to connect the OTG port of the Z506 and the USB port of the Jetson development host.
- c) Short connect 1 and 9 pins of Button connector and supply power to the system. The power supply shall be maintained for more than 3 seconds, and then disconnect 1 and 9 pin short wiring of Button connector. The system enters the Recovery mode, and subsequent operations can be carried out at this point.

4 Connectors Description

4.1 Mini HDMI interface

Function	HDMI output interface	
marking	HDMI	
Type	Mini HDMI connector	

4.2 Ethernet connector

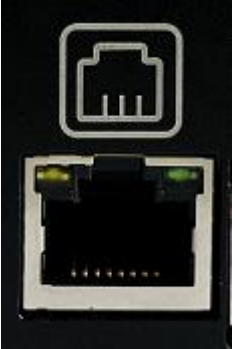
Function	Gigabit Ethernet connector	
marking	ETH	
Type	RJ45	

4.3 USB3.0 interface

Function	USB3.0 interface	
marking	USB3.0	
Type	Type-A The upper layer is USB2.0 The lower layer is USB3.0	

4.4 SD Card Slot

Function	SD Card Slot	
marking	TF card	
Type	Micro SD (TF)	

4.5 Power input port

Function	Power input port	
marking	12V	
Type	2 Pin interface Note: The position of the red box in the right picture is positive.	

4.6 OTG-USB2.0 interface

Function	USB2.0 (OTG) connectors	
marking	OGT	
Type	UBS2.0 Micro Type-B	

4.7 Function connector

Function	Serial port																									
marking	URT/I2C																									
Type	DB9																									
Pin define	<table border="1"> <thead> <tr> <th>Pin</th> <th>Signal</th> <th>Pin</th> <th>Signal</th> </tr> </thead> <tbody> <tr> <td>1</td> <td>UART2_TXD</td> <td>2</td> <td>UART2_RTS</td> </tr> <tr> <td>3</td> <td>UART3_TXD</td> <td>4</td> <td>UART3_RTS</td> </tr> <tr> <td>5</td> <td>GND</td> <td>6</td> <td>UART2_RXD</td> </tr> <tr> <td>7</td> <td>UART2_CTS</td> <td>8</td> <td>UART3_RXD</td> </tr> <tr> <td>9</td> <td>UART3_CTS</td> <td></td> <td></td> </tr> </tbody> </table>		Pin	Signal	Pin	Signal	1	UART2_TXD	2	UART2_RTS	3	UART3_TXD	4	UART3_RTS	5	GND	6	UART2_RXD	7	UART2_CTS	8	UART3_RXD	9	UART3_CTS		
Pin	Signal		Pin	Signal																						
1	UART2_TXD		2	UART2_RTS																						
3	UART3_TXD	4	UART3_RTS																							
5	GND	6	UART2_RXD																							
7	UART2_CTS	8	UART3_RXD																							
9	UART3_CTS																									

Function	Multi-function interface																									
marking	Button																									
Type	DB9																									
Pin define	<table border="1"> <thead> <tr> <th>Pin</th> <th>Signal</th> <th>Pin</th> <th>Signal</th> </tr> </thead> <tbody> <tr> <td>1</td> <td>GND</td> <td>2</td> <td>GND</td> </tr> <tr> <td>3</td> <td>GND</td> <td>4</td> <td>GND</td> </tr> <tr> <td>5</td> <td>GND</td> <td>6</td> <td>DEV_3V3</td> </tr> <tr> <td>7</td> <td>DEV_3V3</td> <td>8</td> <td>BUTTON_PWR_ON</td> </tr> <tr> <td>9</td> <td>FORCE_RECOVER Y</td> <td></td> <td></td> </tr> </tbody> </table>		Pin	Signal	Pin	Signal	1	GND	2	GND	3	GND	4	GND	5	GND	6	DEV_3V3	7	DEV_3V3	8	BUTTON_PWR_ON	9	FORCE_RECOVER Y		
Pin	Signal		Pin	Signal																						
1	GND		2	GND																						
3	GND	4	GND																							
5	GND	6	DEV_3V3																							
7	DEV_3V3	8	BUTTON_PWR_ON																							
9	FORCE_RECOVER Y																									

4.8 WiFi antenna connector

Function	WiFi antenna interface	
marking	AT1 AT2	
Type	ipex to sma female	

5 Hardware update history

Z506 Hardware Update History

edition	Updata description
V1.0	Initial release
V2.0	Change the power supply to 12V power supply

6 Product size diagram

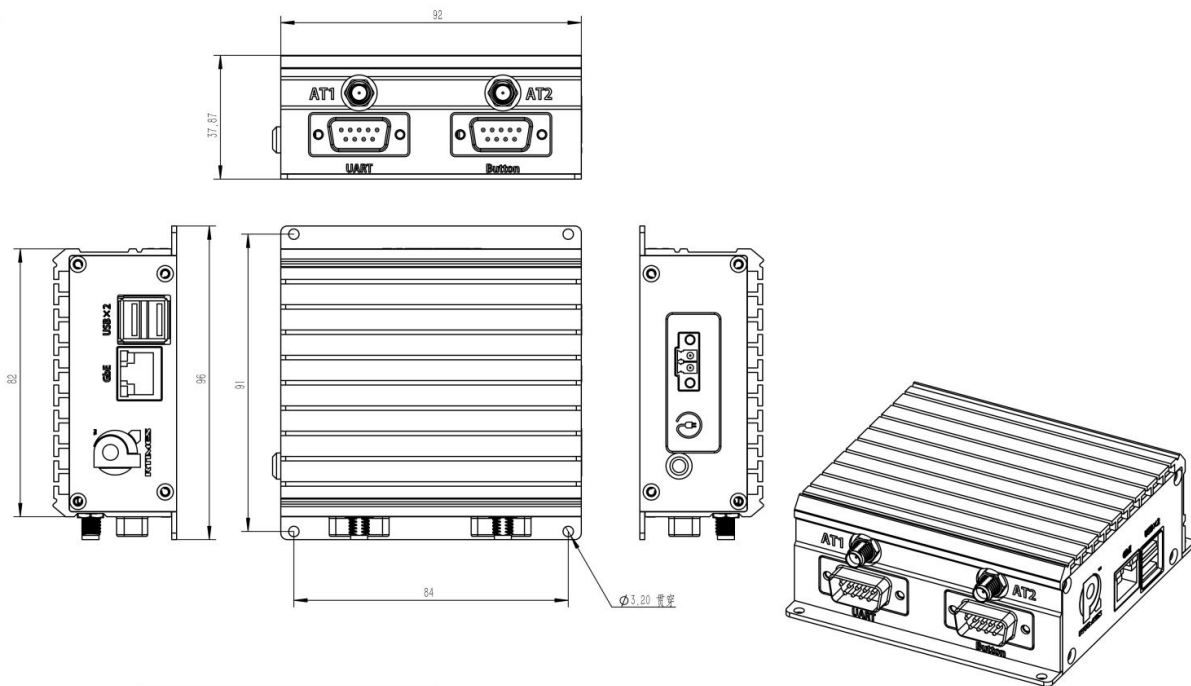



7 Software/BSP Details

The Z506 board works on systems that burn using the official original NVIDIA Linux For Tegra (L4T) ,HDMI, gigabit Ethernet, USB2.0, serial port, GPIO, SD card, I2C bus, fan interface, can be supported. But Mini-PCIe, USB3.0, can't work normally.

The full support of Z506 rugged machine interface needs to load supporting driver patches.

NVIDIA LT4 package can be downloaded from the following link

<https://developer.nvidia.com/embedded/linux-tegra>

RTSS-X501N patch support package download

<http://www.realtimesai.com>

Terms of Warranty

Important note

Each embedded product provided by Realtimes Technology is free from any defects in material and process,fully in line with the specifications officially issued by the original factory.

Realtimes Technology warranty covers the original products,If the parts configured by the dealer are out of order, please consult with the dealer to solve the problem. All the baseplate and core modules provided by Ruitai New Era (Beijing) Technology Co., Ltd. are guaranteed for 3 years, while the other peripherals are guaranteed for 1 year (life-long maintenance service is provided if the warranty period is beyond the warranty period).The warranty period starts from the date of delivery, for the products repaired within the warranty period, the repair parts shall be extended for 12 months.Unless notified by Realtimes Technology, the date of your original invoice shall be the date of shipment.

How do I get warranty services

If the product does not work properly, Please contact Realtimes Technology or dealer for warranty service, please show invoice when product warranty(this is the proof for you getting warranty service).

Warranty solution

When you ask for warranty service, please follow Realtimes Technology warranty process,You will need to receive your first diagnosis from a technical engineer by phone or by email,at that time,we need you to cooperate with us to fill in all the questions on the RMA form provided by us. Once we accurately determine the cause of the fault and the location of the damage ,we will provide the charge list for the out of warranty products,which needs your confirmation.Realtimes Technology keep the right to repair or replace the products. If the product is replaced or repaired, the replaced faulty product or the repaired and replaced faulty parts will be returned to Realtimes Technology.

For products under warranty,the customer shall bear the freight when the product is returned to the manufacturer,Realtimes Technology will bear the ship cost of the products after maintenance.

The following conditions are not covered by the warranty terms

- a) Improper installation, improper use, misuse and abuse of products(Overloading, for example).
- b) Improper maintenance and storage (Such as fire, explosion, etc) or natural disasters (such as lightning stroke,earthquake,typhoon,etc)
- c) Personal unauthorized changing the product(such as changing circuit characteristics, mechanical characteristics, software characteristics,Conformal coating).
- d) Other failures which are clearly due to misuse(such as overvoltage,polarity reversal, the pin bent or broken,the wrong connection,drop damage,transportation damage,damage due to over operating temperature and so on).
- e) The logo and part number on the product have been deleted or removed.
- f) The product is out of warranty.

Special concerns

If the same fault multiple occurrence for the products,in order to find out the reason causing the problem,we will request the users to provide the specific documents or information of peripheral equipment,such as monitor,I/O boards,cables,power supply, diagram and structure of the system,etc.If such documents or information are not available,we have the right to refuse to perform the warranty, the repairments will be charged accordingly.

Rev.C 2/2020